

FRAMECRETE

FLOOR PANEL

INSTALLATION GUIDE FOR CLADDING
2023

INDEX

INDEX	02
INSTALLATION GUIDELINES	03
BEFORE STARTING	04
LITECON FLOOR PANEL DIMENSIONS	05
TYPICAL WOOD STUD FRAME - SUPPORTS @ 16" OR 24"	06
FLOOR - ESQUEMATIC SUBSEQUENT ROWS	07
FLOOR - SUBSEQUENT ROWS	08
FLOOR PANEL DETAILS	09
SECTION A - DETAIL 01 ISOMETRIC	10

INSTALLATION GUIDELINES

- THE FOLLOWING DRAWINGS ASSEMBLIES AND CONSTRUCTION DETAILS ARE FOR ILLUSTRATION PURPOSES ONLY.
- CONSULT DESIGN AUTHORITY AND CONFIRM COMPLIANCE CODE.
- LITECON DOES NOT PROVIDE DESIGN SERVICES
- CHECK PLUMB AND ALIGNMENT OF JOIST OR RAFTER SUPPORTS.
- MINIMUM SPACES FOR INSTALL 16" MAXIMUM 24"
- NO NEED EXPANSION JOINTS DUE TO THE MATERIAL 'S PROPERTIES AND FASTENING DISTANCES.
- CONTROL AND MOVEMENT JOINTS ARE DEFINED ACCORDING TO LOCAL, JURISDICTION,
- SOIL/FOUNDATION PERFORMANCE, GENERAL CONTRACTOR, ARCHITECT AND ENGINEER OF THE
- PROJECT.

BEFORE STARTING

- 1.- BLUEPRINTS
 - 2.- LITECON FIREWALL PANEL 3"
 - 3.- LITECON ADHESIVE
 - 4.- SCREW #10 - 4 1/2" LONG (#3 PHILLIPS HEAD)
 - 5.- TAP WATER
 - 6.- ELECTRIC POWER 110/220V
 - 7.- A 5 GAL. EMPTY BUCKET
 - 8.- GROUT MIXING PADDLE
 - 9.- ELECTRIC DRILL
 - 10.- BATTERY SCREWDRIVER
 - 11.- RUBBER HAMMER
 - 12.- BUBBLE OR LASER KNIFE
 - 13.- JOINT KNIFE
 - 14.- CIRCULAR SAW
 - 15.- 7" DIAMOND TURBO BLADE
-

ACTUAL SIZE FIREWALL PANEL	NOMINAL SIZE FIREWALL PANEL
2.95"	3"
23.82"	2'
48.03"	4'
7.94 SQFT	8 SQFT

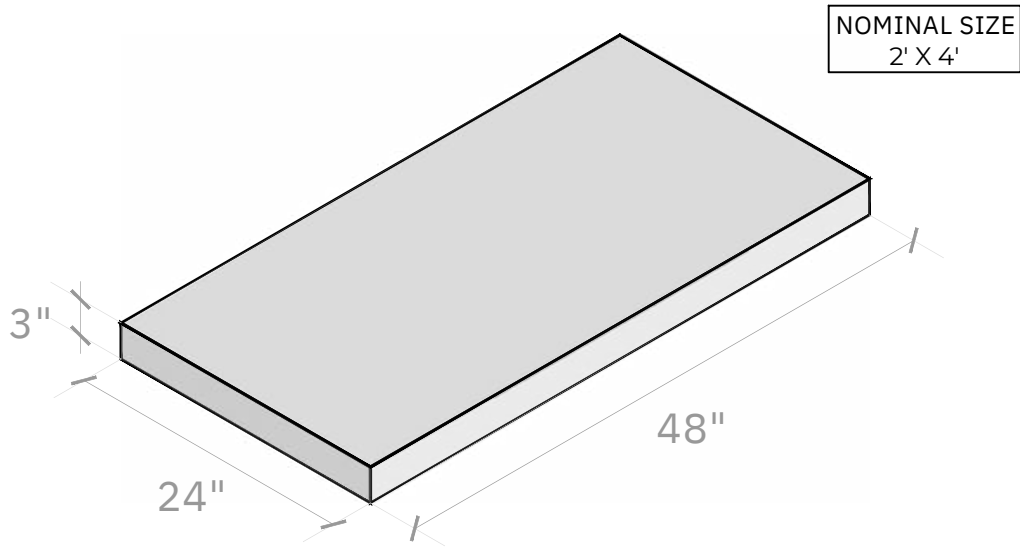

FLOOR - SUBSEQUENT ROWS

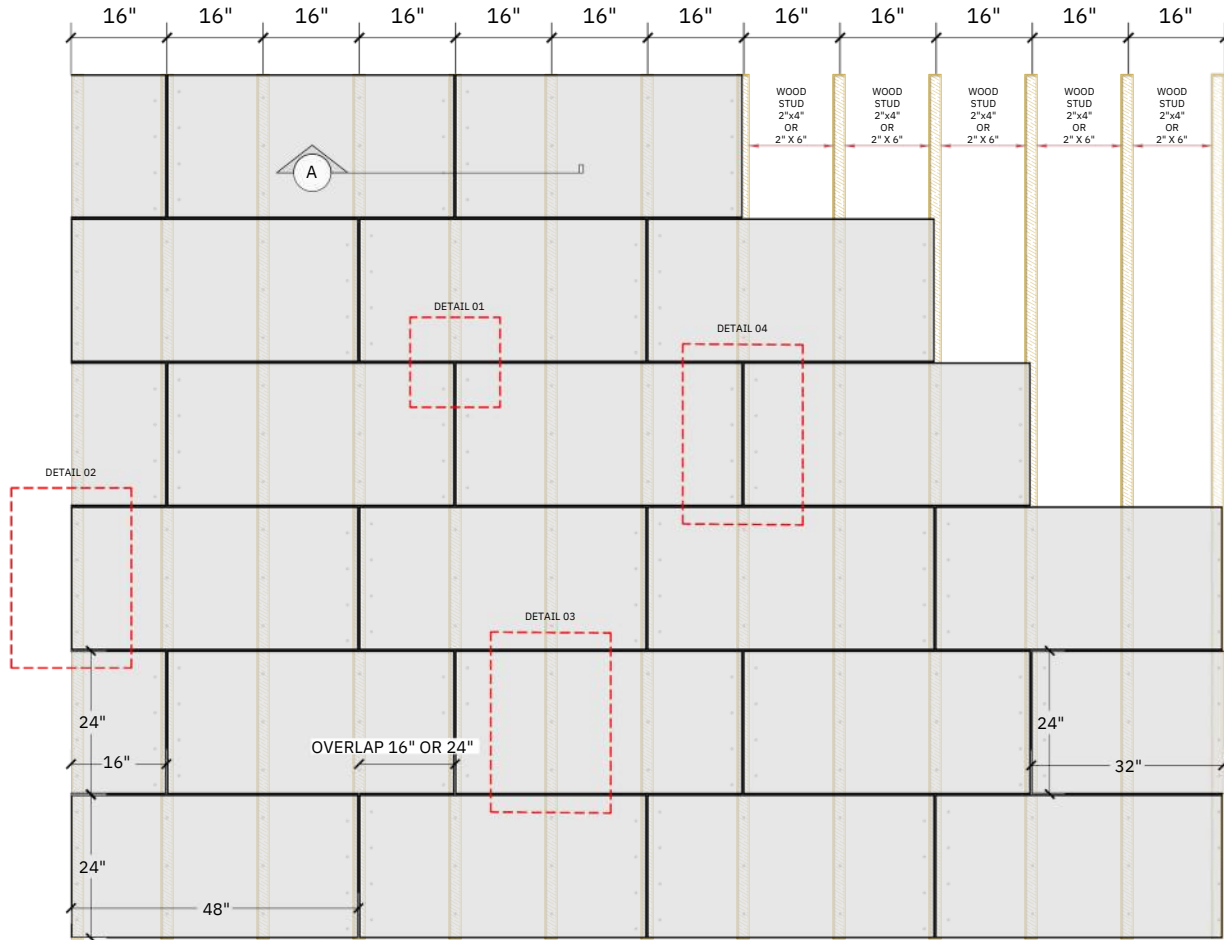

FLOOR PANEL DETAILS

SCREW #10 - 4 1/2" LONG
(#3 PHILLIPS HEAD)

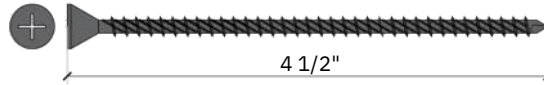

FASTENER FOR WOOD STUD

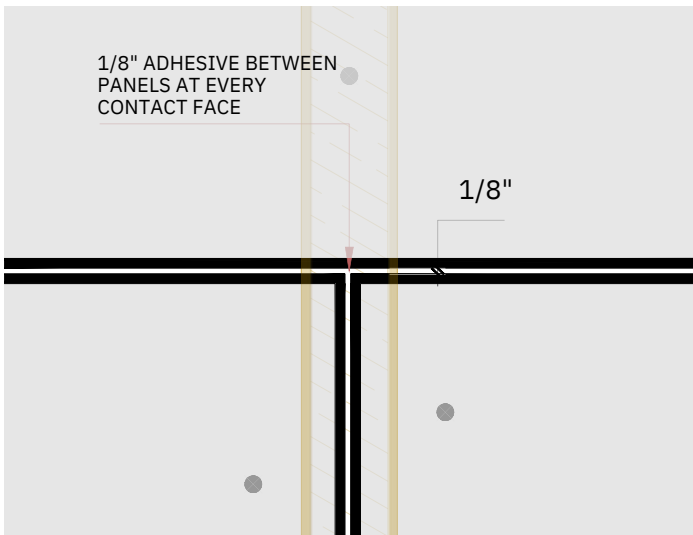

DETAIL 01

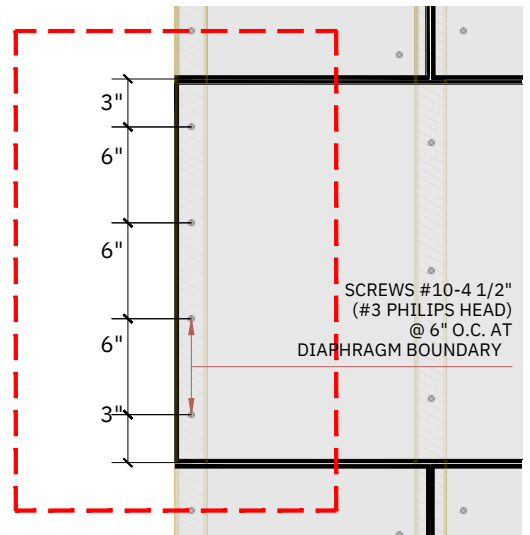

DETAIL 02

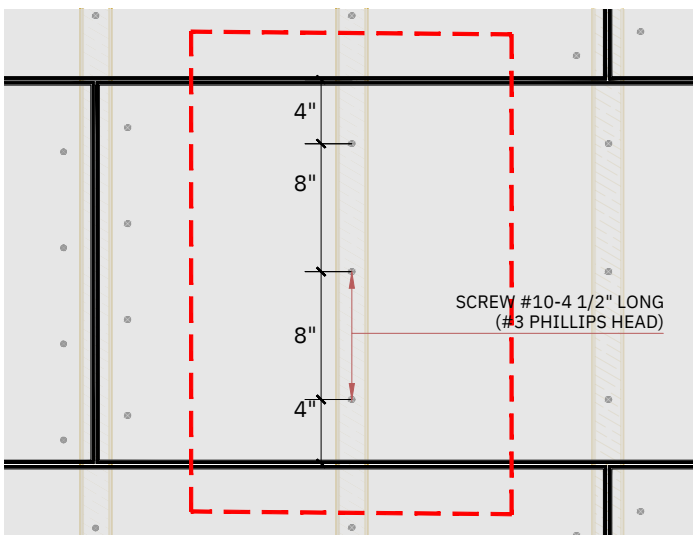

DETAIL 03

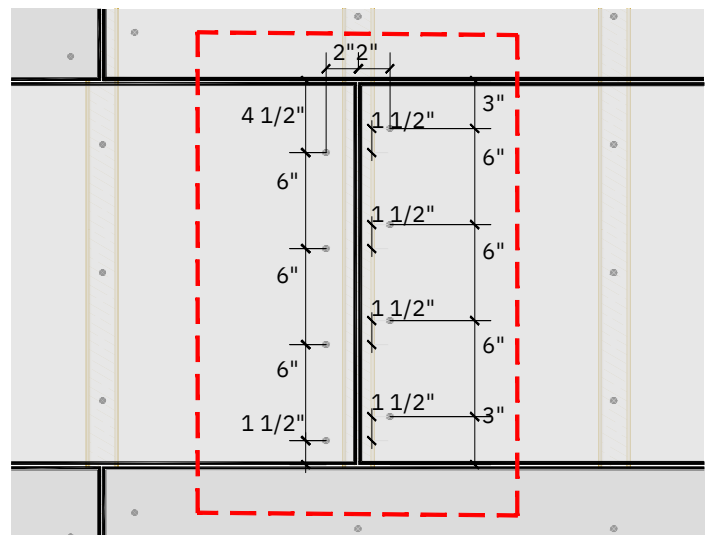

DETAIL 04

SECTION A - DETAIL 01 ISOMETRIC

SECTION A

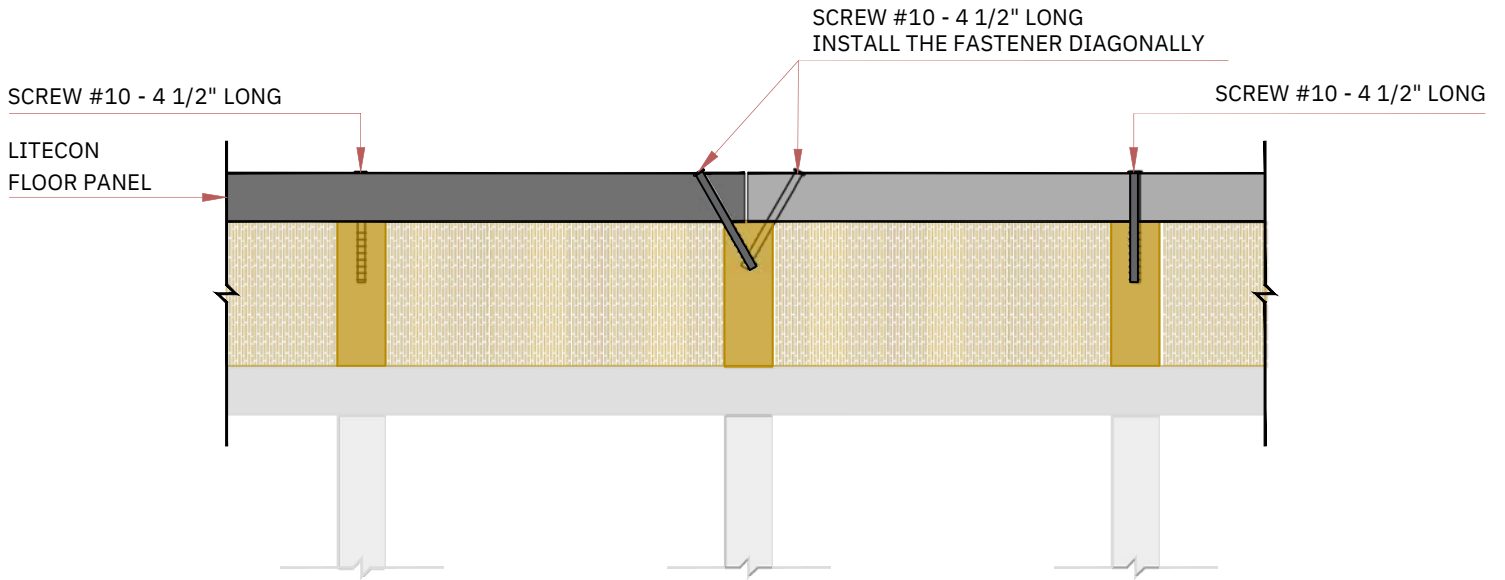

DETAIL 1

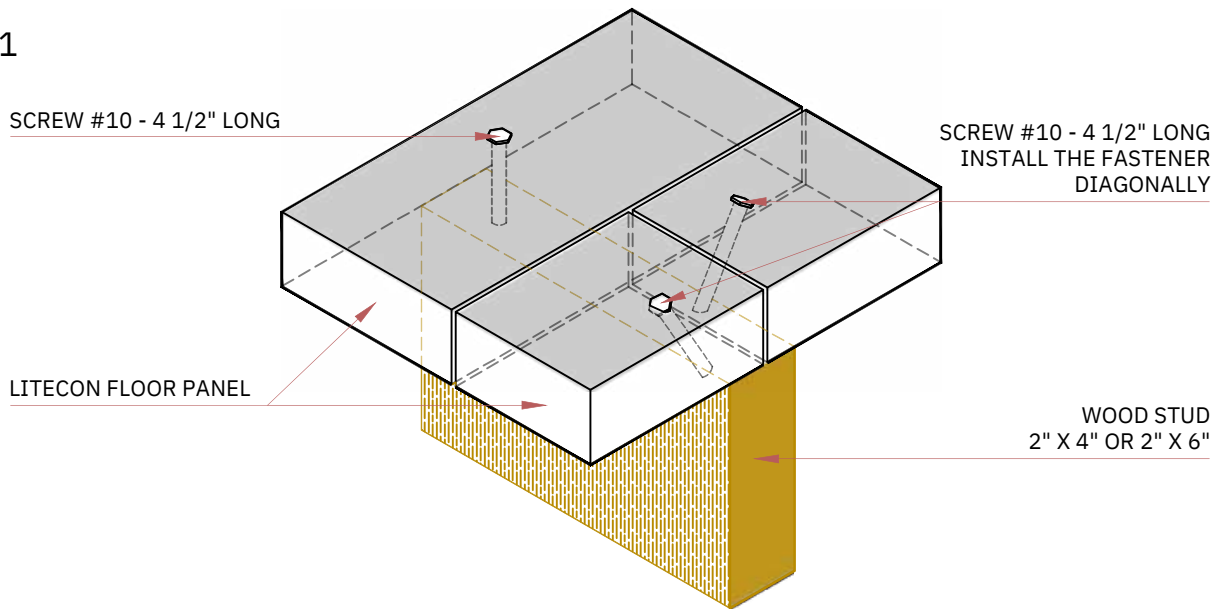

FRAMECRETE

FLOOR PANEL

INSTALLATION GUIDE FOR CLADDING
2023